



P/N LEGEND

F0509 WR-S-XP N L N G1 G TO R
 ① ② ③ ④ ⑤ ⑥ ⑦ ⑧ ⑨ ⑩ ⑪

- ① Series No.
- ② Connector type: WR=Right angle
- ③ Mounting type: S=SMT without boss
- ④ No. of circuits
- ⑤ N=Halogen Free
- ⑥ Material: L=LCP
- ⑦ Color: N=Natural(Beige)
- ⑧ Plating code for contacts: G1=Gold-flash
- ⑨ Plating code for solder tabs: G=Gold-flash
- ⑩ Option code: TO=Top contact style
- ⑪ Packing code: R=Tape & Reel

SPECIFICATIONS

Current Rating: 0.5A AC,DC
 Voltage Rating: 50V AC,DC
 Temperature Range: -25°C ~ +85°C
 Contact Resistance: 30mΩ Max.
 Insulation Resistance: 100MΩ Min.
 Withstanding Voltage: 250V AC/minute
 Contacts: Phosphor Bronze/Gold-flash
 Solder Tabs: Brass/Gold-flash
 Housing: LCP,UL94V-0,Natural(Beige)
 Actuator: Nylon 6T,UL94V-0,Natural(Black)

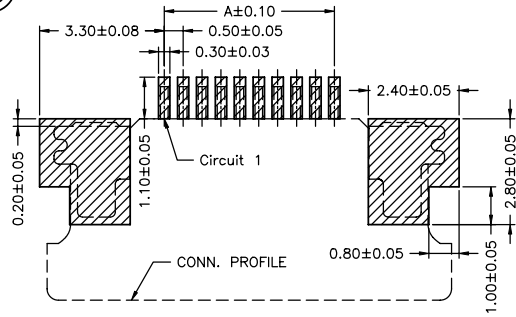

SUGGESTED PCB LAYOUT (TOP VIEW)

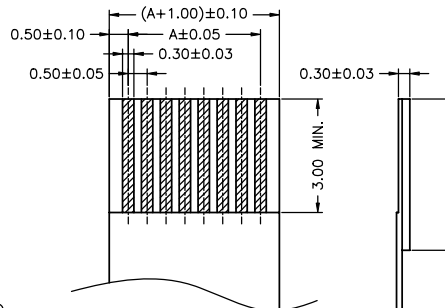
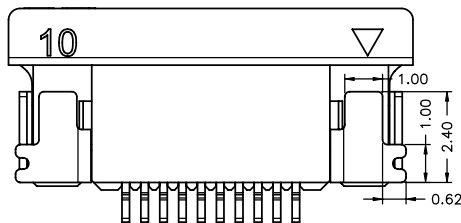
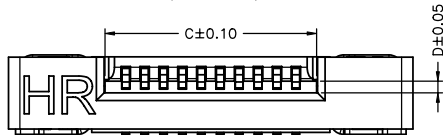
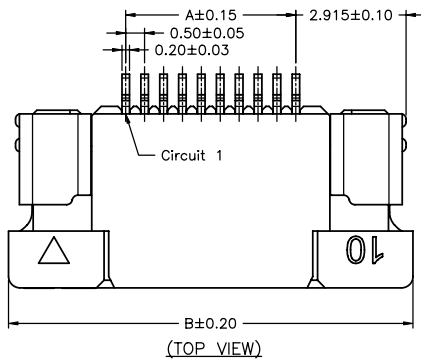

RECOMMENDED FFC/FPC DIMENSION

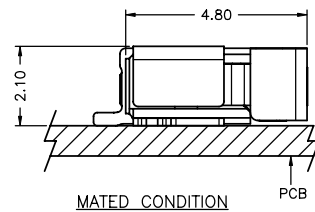
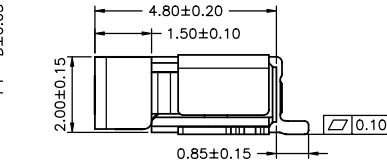
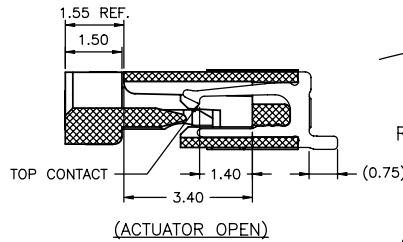

Circuit No.	Dimensions				Circuit No.	Dimensions			
	A	B	C	D		A	B	C	D
04P	1.50	7.70	2.60	0.260	24P	11.50	17.70	12.60	0.310
05P	2.00	8.20	3.10	0.260	25P	12.00	18.20	13.10	0.310
06P	2.50	8.70	3.60	0.260	26P	12.50	18.70	13.60	0.310
07P	3.00	9.20	4.10	0.310	27P	13.00	19.20	14.10	0.310
08P	3.50	9.70	4.60	0.310	28P	13.50	19.70	14.60	0.310
09P	4.00	10.20	5.10	0.310	29P	14.00	20.20	15.10	0.310
10P	4.50	10.70	5.60	0.310	30P	14.50	20.70	15.60	0.310
11P	5.00	11.20	6.10	0.310	31P	15.00	21.20	16.10	0.310
12P	5.50	11.70	6.60	0.310	32P	15.50	21.70	16.60	0.310
13P	6.00	12.20	7.10	0.310	33P	16.00	22.20	17.10	0.310
14P	6.50	12.70	7.60	0.310	34P	16.50	22.70	17.60	0.310
15P	7.00	13.20	8.10	0.310	35P	17.00	23.20	18.10	0.310
16P	7.50	13.70	8.60	0.310	36P	17.50	23.70	18.60	0.310
17P	8.00	14.20	9.10	0.310	37P	18.00	24.20	19.10	0.310
18P	8.50	14.70	9.60	0.310	38P	18.50	24.70	19.60	0.310
19P	9.00	15.20	10.10	0.310	39P	19.00	25.20	20.10	0.310
20P	9.50	15.70	10.60	0.310	40P	19.50	25.70	20.60	0.310
21P	10.00	16.20	11.10	0.310	41P	20.00	26.20	21.10	0.310
22P	10.50	16.70	11.60	0.310	45P	22.00	28.20	23.10	0.310
23P	11.00	17.20	12.10	0.310	50P	24.50	30.70	25.60	0.310

				UNIT	SCALE	SHEET	TITLE:
				mm	1 : 1	1 of 2	
DRAWN BY		APPROVED BY		0.50mm PITCH FFC/FPC CONNECTOR, 90° SMT TYPE, ZIF, TOP CONTACT STYLE			
權生新		J.C.					
2010.05.31		2010.05.31		DRAW NO. :			
GENERAL TOLERANCE				F0509WR-S-XPXXXXXXTOX			
X.X±0.25		ANGLE±		REV.			
X.XX±0.15		⌀		A1			
X.XXX±0.05							
REV.	DESCRIPTION	DATE	NAME				

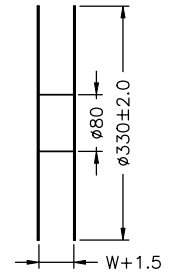
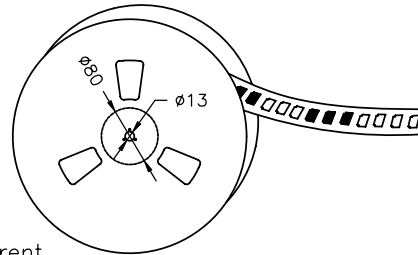
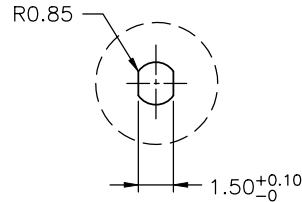
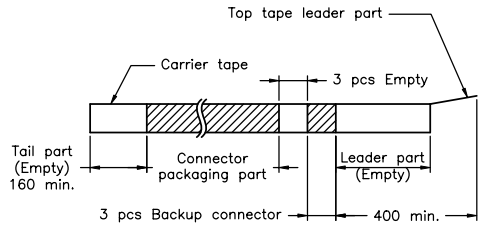
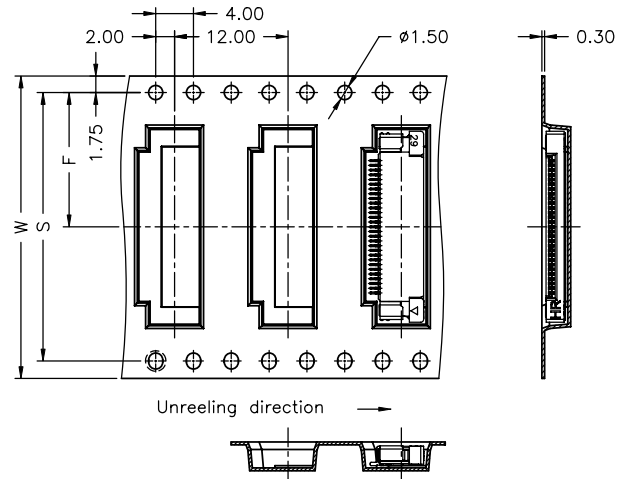
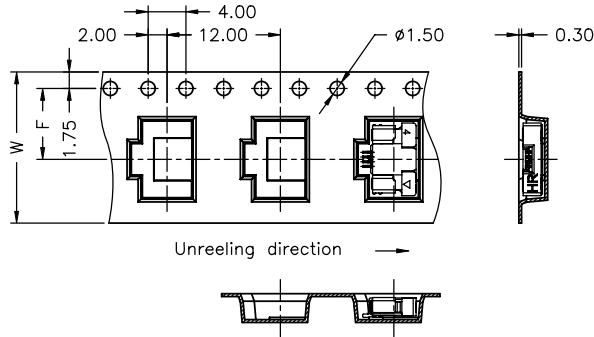

NOTE:

Material: Transparent Anti-static Polystyrene.

Number of Contacts	W±0.3	F±0.1	S±0.1	Q'ty/Reel	Number of Contacts	W±0.3	F±0.1	S±0.1	Q'ty/Reel
04P	16	7.50		2,000	24P	32	14.20	28.40	2,000
05P	16	7.50		2,000	25P	32	14.20	28.40	2,000
06P	24	11.50		2,000	26P	32	14.20	28.40	2,000
07P	24	11.50		2,000	27P	32	14.20	28.40	2,000
08P	24	11.50		2,000	28P	32	14.20	28.40	2,000
09P	24	11.50		2,000	29P	32	14.20	28.40	2,000
10P	24	11.50		2,000	30P	32	14.20	28.40	2,000
11P	24	11.50		2,000	31P	44	20.20	40.40	2,000
12P	24	11.50		2,000	32P	44	20.20	40.40	2,000
13P	24	11.50		2,000	33P	44	20.20	40.40	2,000
14P	24	11.50		2,000	34P	44	20.20	40.40	2,000
15P	24	11.50		2,000	35P	44	20.20	40.40	2,000
16P	24	11.50		2,000	36P	44	20.20	40.40	2,000
17P	24	11.50		2,000	37P	44	20.20	40.40	2,000
18P	24	11.50		2,000	38P	44	20.20	40.40	2,000
19P	24	11.50		2,000	39P	44	20.20	40.40	2,000
20P	24	11.50		2,000	40P	44	20.20	40.40	2,000
21P	24	11.50		2,000	41P	44	20.20	40.40	2,000
22P	32	14.20	28.40	2,000	45P	44	20.20	40.40	2,000
23P	32	14.20	28.40	2,000	50P	44	20.20	40.40	2,000

						燦達電子工業股份有限公司 JOINT TECH ELECTRONIC IND. CO., LTD.	
		UNIT	SCALE	SHEET		TITLE:	
		mm	1 : 1	2 of 2		0.50mm PITCH FFC/FPC	
		DRAWN BY		APPROVED BY		CONNECTOR, 90° SMT TYPE,	
		權生新		J. C.		ZIF, TOP CONTACT STYLE,	
		2010.05.31		2010.05.31		TAPING SPEC.	
		GENERAL TOLERANCE					
		X.X±0.25		ANGLE±		DRAW NO. :	
A1		ENI107140280		2011.07.14		F0509WR-S-XPXXXXXXTOX	
REV.		DESCRIPTION		DATE		NAME	
						REV. A1	