

Ordering code

- A2001 WR-S-XP N X X XX X 00 R  
① ② ③ ④ ⑤ ⑥ ⑦ ⑧ ⑨ ⑩ ⑪
- ① Series No.
  - ② Connector type: WR=Right angle
  - ③ Mounting type: S=SMT without boss
  - ④ No. of circuits
  - ⑤ N=Halogen Free
  - ⑥ Material: 6=Nylon 6T, L=LCP
  - ⑦ Color: B=Black, N=Natural(Beige)
  - ⑧ Plating code for contacts: T1=Matte Tin-plated  
G1=Gold-flash
  - ⑨ Plating code for solder tabs: T=Matte Tin-plated  
G=Gold-flash
  - ⑩ Option code: 00=Standard
  - ⑪ Packing code:  
R=Tape & Reel(Without Cap or Mylar)

SPECIFICATIONS

Current Rating: 2A AC,DC  
Voltage Rating: 100V AC,DC  
Temperature Range: -25°C ~ +85°C  
Contact Resistance: 10mΩ Max.  
Insulation Resistance: 1000MΩ Min.  
Withstanding Voltage: 800V AC/minute  
Pin Material: Brass/Matte Tin-plated  
or Gold-flash  
Solder Tabs: Brass/Matte Tin-plated  
or Gold-flash

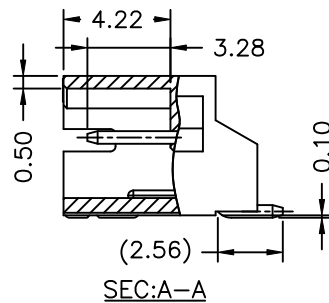
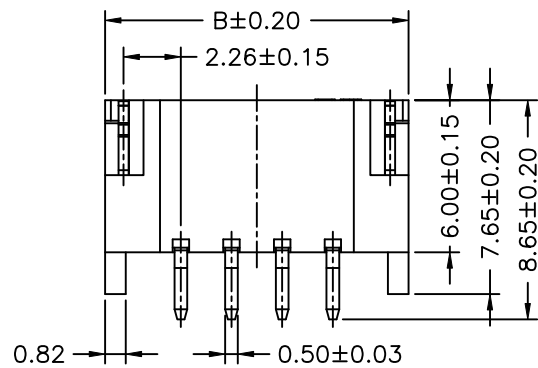
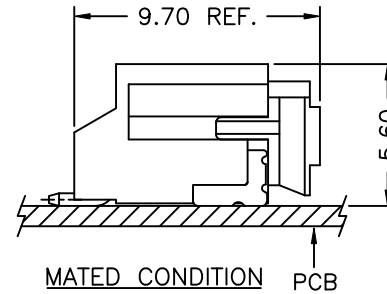
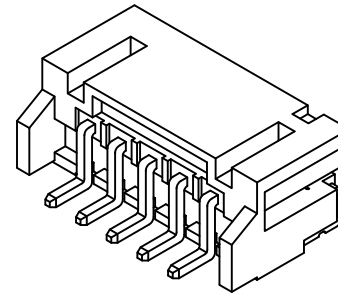
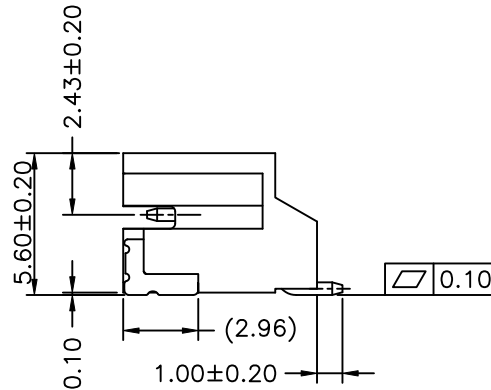
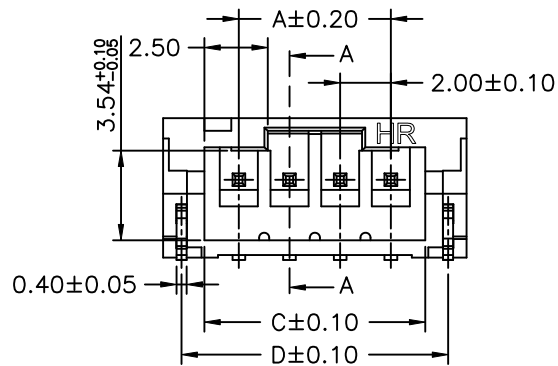

Circuit No.	Dimensions			
	A	B	C	D
02P	2.00	8.00	4.72	6.52
03P	4.00	10.00	6.72	8.52
04P	6.00	12.00	8.72	10.52
05P	8.00	14.00	10.72	12.52
06P	10.00	16.00	12.72	14.52
07P	12.00	18.00	14.72	16.52
08P	14.00	20.00	16.72	18.52
09P	16.00	22.00	18.72	20.52
10P	18.00	24.00	20.72	22.52
11P	20.00	26.00	22.72	24.52
12P	22.00	28.00	24.72	26.52
13P	24.00	30.00	26.72	28.52
14P	26.00	32.00	28.72	30.52
15P	28.00	34.00	30.72	32.52
16P	30.00	36.00	32.72	34.52

				燦達電子工業股份有限公司 JOINT TECH ELECTRONIC IND. CO., LTD.	
		UNIT	SCALE	SHEET	TITLE:
		mm		1 of 2	2.00mm PITCH 90° WAFER-SMT TYPE
		DRAWN BY	APPROVED BY		
		陳敏	童冠銘		
		2010.05.25	2010.05.25		
A2	Add Lcp Material	2016.01.20	唐騰鳳	GENERAL TOLERANCE	
A1	ENI310310376	2013.10.31	郭本思		
A0	NEW RELEASE	2010.05.25	陳敏	ANGLE±	
REV.	DESCRIPTION	DATE	NAME		
		X.X±0.25			DRAW NO. :
		X.XX±0.15			
		X.XXX±0.05		A2	



02~05 Contacts

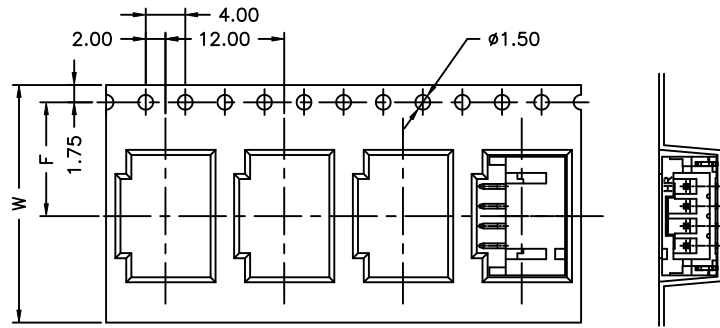

06~16 Contacts

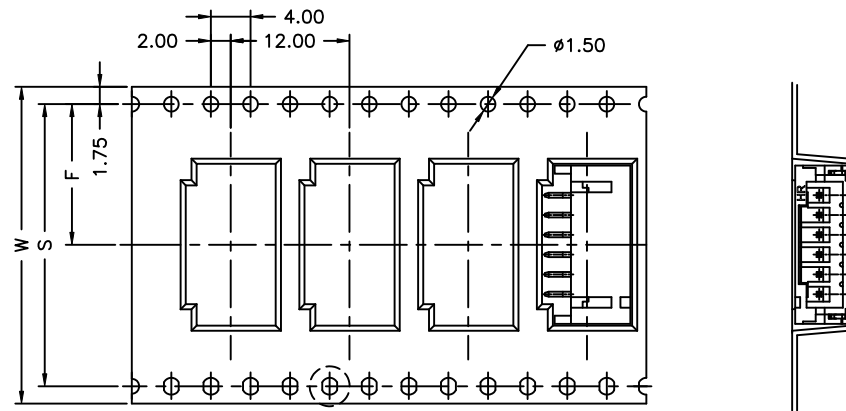

Unreeling direction →

Unreeling direction →

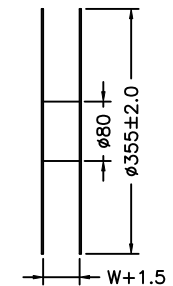
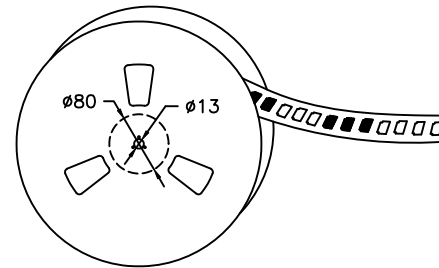
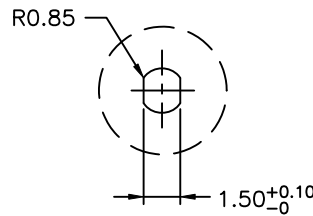
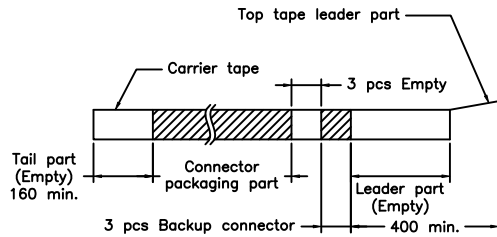

Number of Contacts	W±0.3	F±0.1	S±0.1	Q'ty/Reel
02P	16	7.50	/	1000
03P	24	11.50		1000
04P	24	11.50		1000
05P	24	11.50		1000
06P	32	14.20	28.40	1000
07P	32	14.20	28.40	1000
08P	32	14.20	28.40	1000
09P	44	20.20	40.40	1000
10P	44	20.20	40.40	1000
11P	44	20.20	40.40	1000
12P	44	20.20	40.40	1000
13P	56	26.20	52.40	1000
14P	56	26.20	52.40	1000
15P	56	26.20	52.40	1000
16P	56	26.20	52.40	1000

NOTE:  
Material: Transparent  
Anti-static Polystyrene.

燦達電子工業股份有限公司 JOINT TECH ELECTRONIC IND. CO., LTD.				UNIT	SCALE	SHEET	TITLE:
				mm		2 of 2	
DRAWN BY		APPROVED BY		GENERAL TOLERANCE		2.00mm PITCH 90° WAFER-SMT TYPE, TAPING SPEC.	
陳敏		童冠銘					
2010.05.25		2010.05.25					
A2 Add Lcp Material		2016.01.20 唐騰鳳		X.X±0.25	ANGLE±		
A1 ENI310310376		2013.10.31 郭本思		X.XX±0.15	DRAW NO. : A2001WR-S-XPXXXXXXX		
A0 NEW RELEASE		2010.05.25 陳敏		X.XXX±0.05			
REV.	DESCRIPTION	DATE	NAME			REV.	A2